



# 光电耦合器

## OPTOCOUPLER

产品规格书  
Product Data Sheet

# Si-816 系列

## Si-816 Series

Si DCC  
Release

贵州硅耐光电有限公司

GuiZhou Silicon Nice Optoelectronic Co., Ltd.

## 描述 Description

Si-816 系列有一个发光二极管，通过红外光与硅基光电晶体管耦合并合封在四脚小型封装中。该产品的小尺寸封装可显著节省安装空间。

The Si-816 series has a infrared emitting diode, which is optically coupled to a silicon planar phototransistor detector, and is incorporated in 4-pin flat package. The small dimension of this product allows significant space saving.

## 典型应用 Typical Applications

- 电源适配器  
AC Adapters
- I/O 接口隔离  
I/O Interface Boards
- 可编程控制器  
Programmable Logic Controllers (PLCs)
- 家用电器，比如空调、风扇、热水器等  
Household appliances: such as air conditioners, fans, water heaters, etc.

## 特性 Features

- 电流转换比(CTR)范围: 80%~600% ( $I_F = 5\text{mA}$ ,  $V_{CE} = 5\text{V}$ )  
Current Transfer Ratio: 80% to 600% at  $I_F = 5\text{mA}$ ,  $V_{CE} = 5\text{V}$
- 集电极-发射极耐压  $V_{CEO} \geq 80\text{V}$   
Collector - emitter Voltage  $V_{CEO} \geq 80\text{V}$
- 输入-输出隔离电压最小 5000  $V_{RMS}$   
Input-output Isolation Voltage 5000  $V_{RMS}(\text{min})$

## 封装与功能图 Package and Functional Diagram

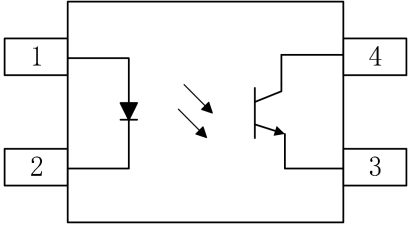
封装 Package	内部连接图 Internal Connection Diagram	引脚分配 Pin Assignment
 <p>DIP-4      DIP4-M      SMD-4</p>		<p>1: Anode 2: Cathode 3: Emitter 4: Collector</p>



## 安规与绝缘参数 Safety and Insulation Ratings

参数 Parameter		符号 Symbol	数值 Value	单位 Unit
最大额定隔离电压 Maximum Rated Withstanding Isolation Voltage	According to UL1577, t = 1 min	V <sub>ISO</sub>	5000	V <sub>RMS</sub>
最大瞬态隔离电压 Maximum Transient Isolation Voltage	According to DIN EN 60747-5-5	V <sub>IOTM</sub>	1500	V <sub>peak</sub>
最大峰值重复隔离电压 Maximum Repetitive Peak Isolation Voltage	According to DIN EN 60747-5-5	V <sub>IORM</sub>	7000	V <sub>peak</sub>
爬电距离 Creepage Distance	/	L	>7.0	mm

## 极限参数 Absolute Maximum Ratings (T<sub>amb</sub>=25°C)

参数 Parameter		符号 Symbol	极限值 Rating	单位 Unit
输入端 Input	正向电流 Forward Current	I <sub>F</sub>	50	mA
	反向电压 Reverse Voltage	V <sub>R</sub>	6	V
	功耗 Power Dissipation	P	70	mW
	峰值电流 Peak forward current (1us, pulse)	I <sub>FP</sub>	1	A
	结温 Junction Temperature	T <sub>J</sub>	125	°C
输出端 Output	集电极-发射极电压 Collector - Emitter Voltage	V <sub>CEO</sub>	80	V
	发射极-集电极电压 Emitter - Collector Voltage	V <sub>ECO</sub>	7	V
	集电极电流 Collector Current	I <sub>C</sub>	50	mA
	集电极功耗 Collector Power Dissipation	P <sub>C</sub>	150	mW
	结温 Junction Temperature	T <sub>J</sub>	125	°C
总功耗 Total Power Dissipation		P <sub>tot</sub>	170	mW
工作温度 Operating Temperature		T <sub>amb</sub>	-55~110	°C
存储温度 Storage Temperature		T <sub>stg</sub>	-55~125	°C
焊接温度 Soldering Temperature		T <sub>sld</sub>	260	°C



### 特性参数 Electro-optical Characteristics ( $T_{amb}=25^{\circ}C$ )

参数 Parameter		测试条件 Test Conditions	符号 Symbol	最小值 Min.	典型值 Typ.	最大值 Max.	单位 Units
输入端 Input	正向电压 Forward Voltage	$I_F=10mA$	$V_F$	-	1.2	1.4	V
	反向电流 Reverse current	$V_R=4V$	$I_R$	-	-	10	$\mu A$
	输入端电容 Input capacitance	$V=0, f=1kHz$	$C_{IN}$	-	30	250	pF
输入端 Output	集电极暗电流 Collector Dark Current	$V_{CE}=20V$	$I_{CEO}$	-	-	100	nA
	集电极-发射极击穿电压 Collector-Emitter Breakdown Voltage	$I_C=0.1mA, I_F=0mA$	$BV_{CEO}$	80	-	-	V
	发射极-集电极击穿电压 Emitter-Collector Breakdown Voltage	$I_E=0.01mA, I_F=0mA$	$BV_{ECO}$	7	-	-	V
传输特性 Transfer Characteristics	*电流传输比 *Current Transfer Ratio	$I_F=5mA, V_{CE}=5V$	CTR*	80	-	600	%
	集电极-发射极饱和压降 Collector-Emitter Saturation Voltage	$I_F=20mA, I_C=1mA$	$V_{CE(sat)}$	0	-	0.2	V
	隔离电阻 Isolation Resistance	DC500V, 40~60%R.H.	$R_{ISO}$	$5 \times 10^{10}$	$1 \times 10^{11}$	-	$\Omega$
	隔离电容 Isolation capacitance	$V=0, f=1MHz$	$C_{ISO}$	-	0.6	1	pF
	截止频率 Cut-off Frequency	$V_{CE}=5V, I_C=2mA,$ $R_L=100\Omega, -3dB$	$F_C$	-	80	-	kHz
	上升时间 Rise Time	$V_{CE}=2V, I_C=2mA,$	tr	-	4	-	$\mu s$
	下降时间 Fall Time	$R_L=100\Omega$	tf	-	3	-	$\mu s$

$*CTR = \frac{I_C}{I_F} \times 100\%$

### 电流传输比分档表 Rank Table of Current Transfer Ratio

参数 Parameter	测试条件 Test Conditions	符号 Symbol	最小值 Min.	最大值 Max.	单位 Unit
CTR Rank	$I_F = 5mA, V_{CE} = 5V$ $T_{amb} = 25^{\circ}C$	A	80	160	%
		B	130	260	%
		C	200	400	%
		D	300	600	%
		D1	300	450	%
		D2	380	600	%
		None	80	600	%



# 典型特性曲线 Typical Characteristics Curves

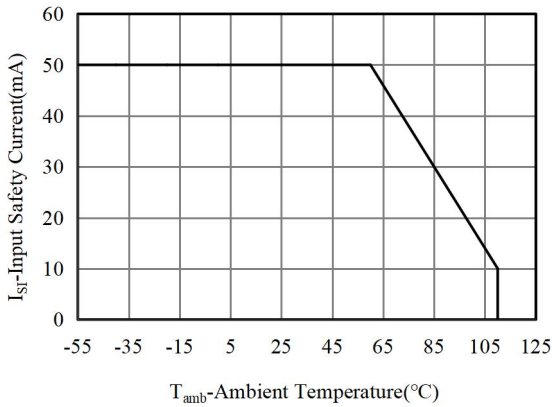

图例 1-输入安全电流与环境温度曲线图

Fig. 1 - Input Safety Current vs. Ambient Temperature

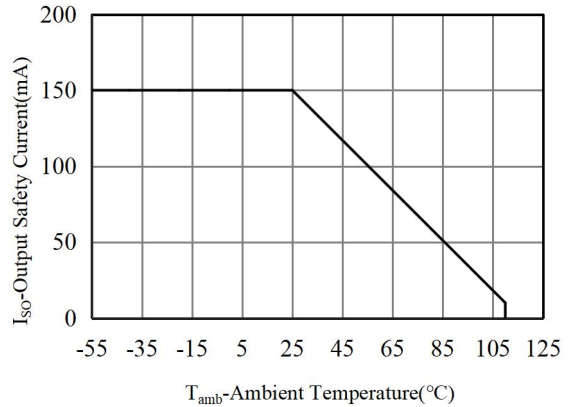

图例 2-输出安全电流与环境温度曲线图

Fig. 2 - Output Safety Power vs. Ambient Temperature

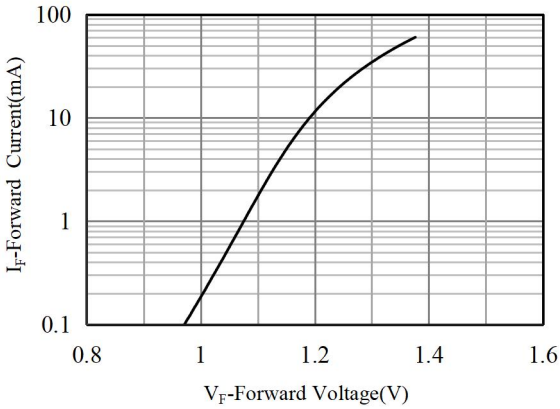

图例 3-正向电流与正向电压曲线图

Fig. 3 - Forward Current vs. Forward Voltage

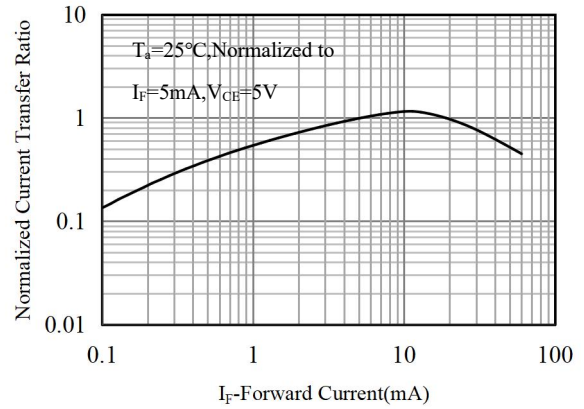

图例 4-归一化电流转换比与正向电流曲线图

Fig. 4 Normalized Current Transfer Ratio vs. Forward Current

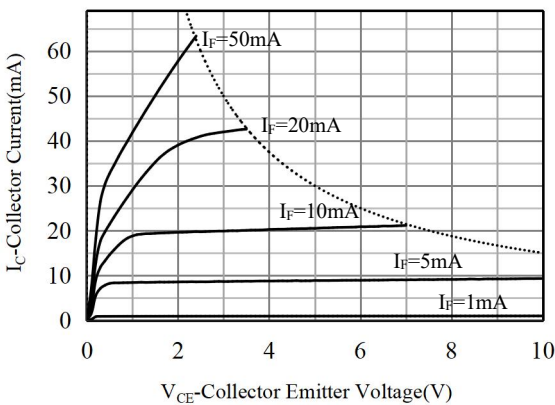

图例 5-集电极电流与集电极-发射极电压曲线图

Fig.5-Collector Current vs. Collector Emitter Voltage

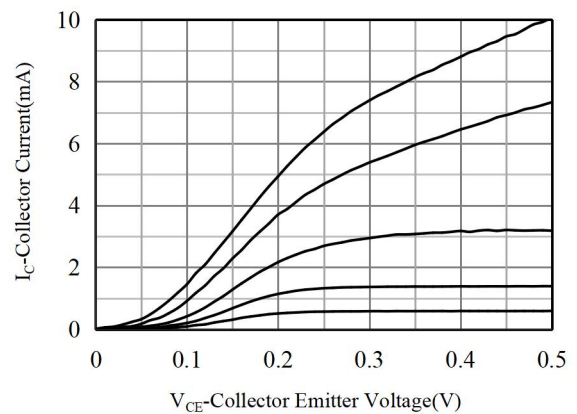

图例 6-集电极电流与集电极-发射极电压曲线图

Fig.-Collector Current vs. Collector Emitter Voltage

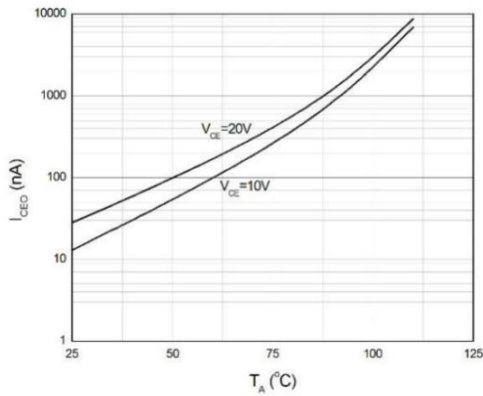

图例 7-集电极暗电流与环境温度曲线图

Fig. 4 Collector Dark Current vs. Ambient Temperature

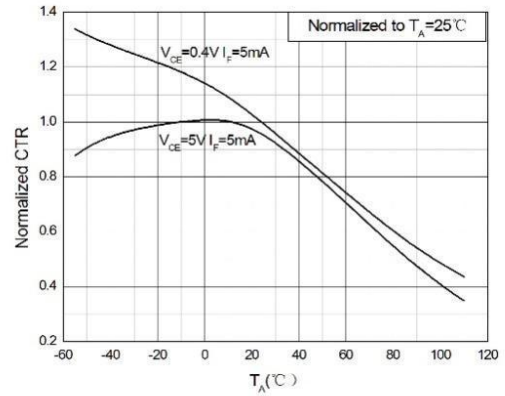

图例 8-归一化电流传输比与环境温度曲线图

Fig. 8 - Normalized Current Transfer Ratio vs. Ambient Temperature

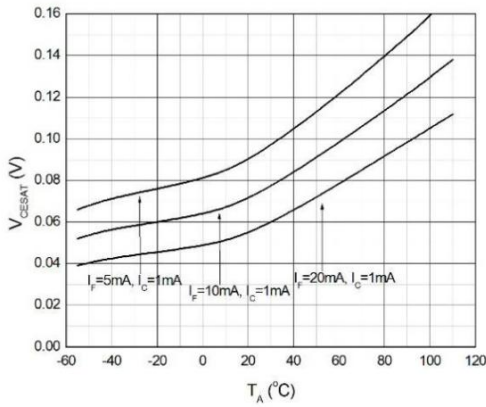

图例 9-集电极-发射极饱和电压与环境温度曲线图

Fig. 9 - Collector-emitter Saturation Voltage vs. Ambient Temperature

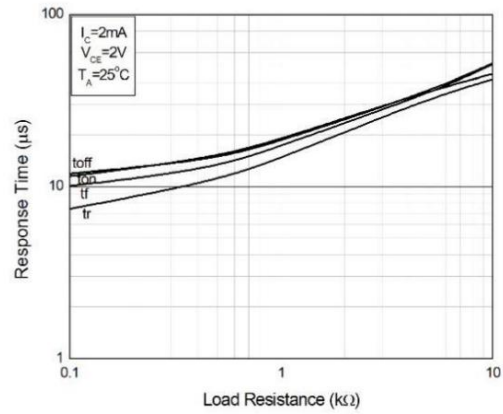

图例 10-响应时间与负载电阻曲线图

Fig. 10 - Response Time vs. Load Resistance

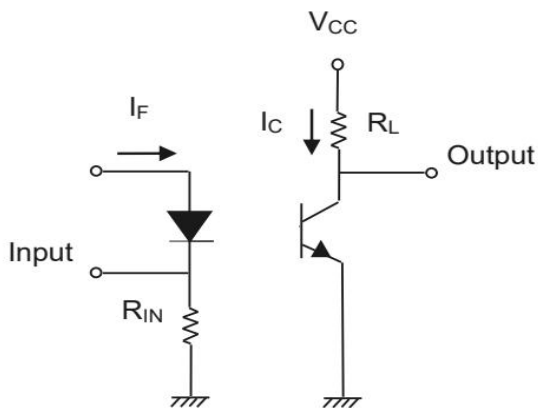

图例 11-开关时间测试电路图

Fig. 11 - Switching Time Test Circuit

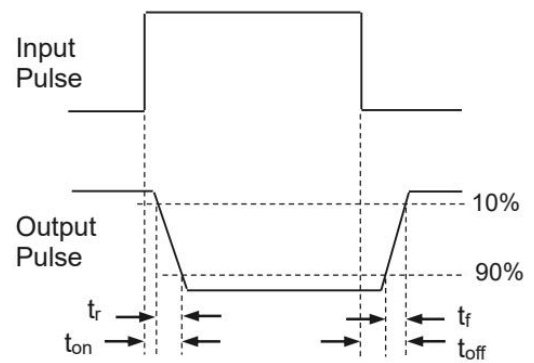

图例 12-开关时间波形图

Fig. 12 - Switching Time Test Waveforms



## 印字信息 Marking Information

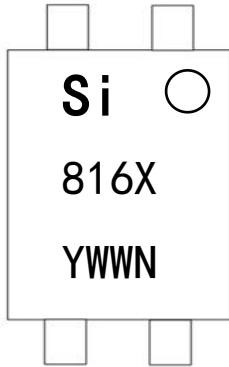

- ◆ Si: 生产商代码 Manufacturer's Code Marking
- ◆ 816: 器件型号代码 Device Part Number
- ◆ X: 电流传输比代码 CTR Rank Code
- ◆ Y: 年代码 Last Digit of Year (ex: 4=2024, 5=2025)
- ◆ WW: 周号代码 Week Code (01 to 53)
- ◆ N: 特殊代码或无 Special code or None

## 命名规则 Naming Rule

# Si-816X-WY-ZTT

- ◆ Si: 生产商代码 Manufacturer's Code Marking
- ◆ 816: 器件型号代码 Device Part Number
- ◆ X: 电流传输比代码 (C、D、D1、D2 或无) CTR Rank Code (C、D、D1、D2 OR None)
- ◆ W: 框架材质 (C=铜)
- ◆ Y: G/None (G=环保, None=非环保)
- ◆ Z: 封装 (Z=D: DIP、Z=S: SMD、Z=M: DIP-M)
- ◆ TT: 补充码 A~Z or 0~9 or None



# 封装外形尺寸 Package Outline Dimensions

DIP-4

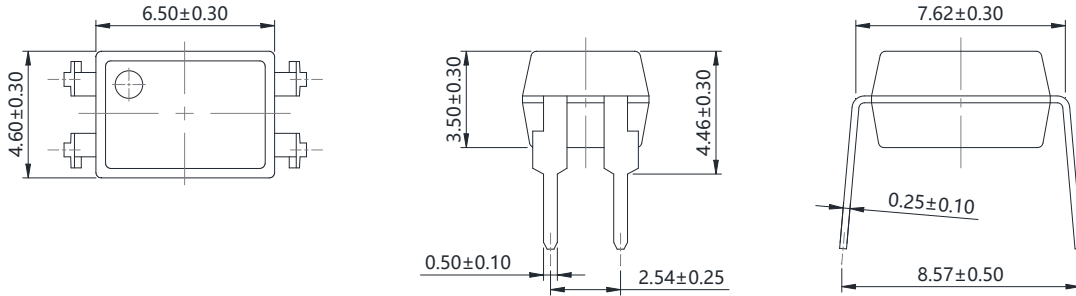

SMD-4

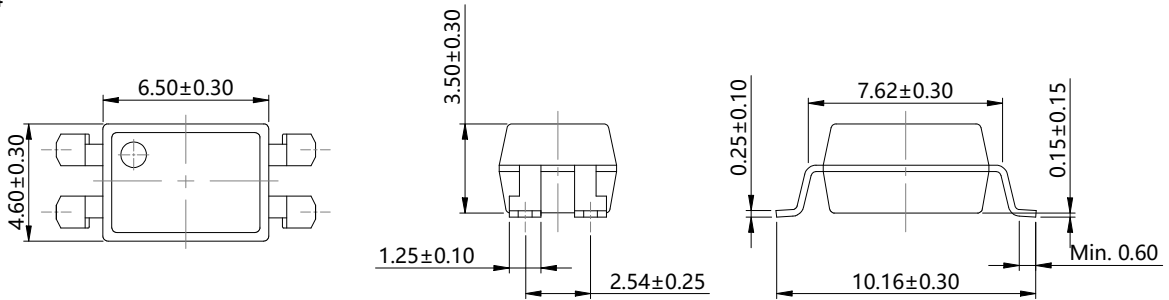

DIP4-M

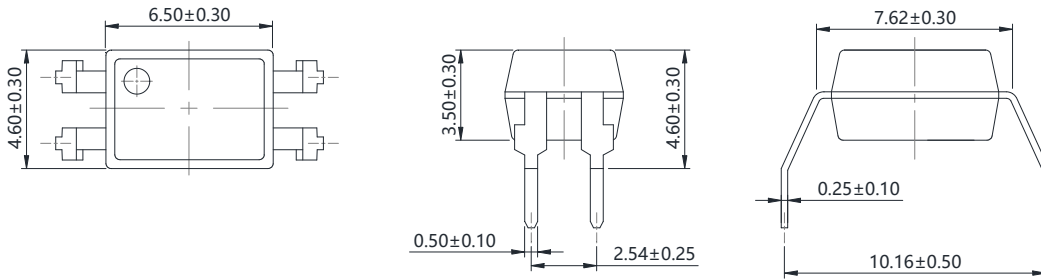

单位: mm

# 推荐焊盘尺寸 Recommended Footprint Patterns

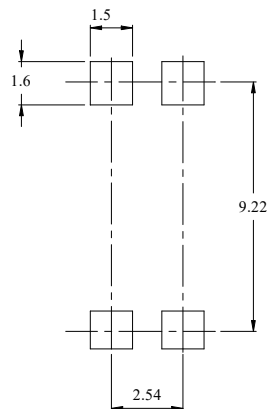

SMD-4



## 包装 Packing

封装 Package Type	包装方式 Packing Form	管/盘数 Quantity per Reel	内盒数量 Quantity per Inner Box	外箱数量 Quantity per Carton	内盒尺寸 Inner Box Dimensions	外箱尺寸 Carton Dimensions	备注 Note
DIP4	管装 Tube (500*12*11 mm)	100 pcs /tube	50 tubes/box	10 boxes/ctn	525*130*57 mm	550*280*320 mm	管两端蓝白塞，方向一致 End plug (blue) and End plug (white) keep the direction
DIP4-M	管装 Tube (500*13*11 mm)	100 pcs /tube	45 tubes/box	8 boxes/ctn	525*130*57 mm	550*280*320 mm	
SMD4	卷盘 Reel ( $\phi$ 330mmBl ue)	2000 pcs/reel	2 reels/box	10 boxes/ctn	353*340*60 mm	650*375*365 mm	首端空 50 个空格，末端 空 100 个空格 Leave 50 Spaces at the beginning and 100 Spaces at the end

## 载带 Tape

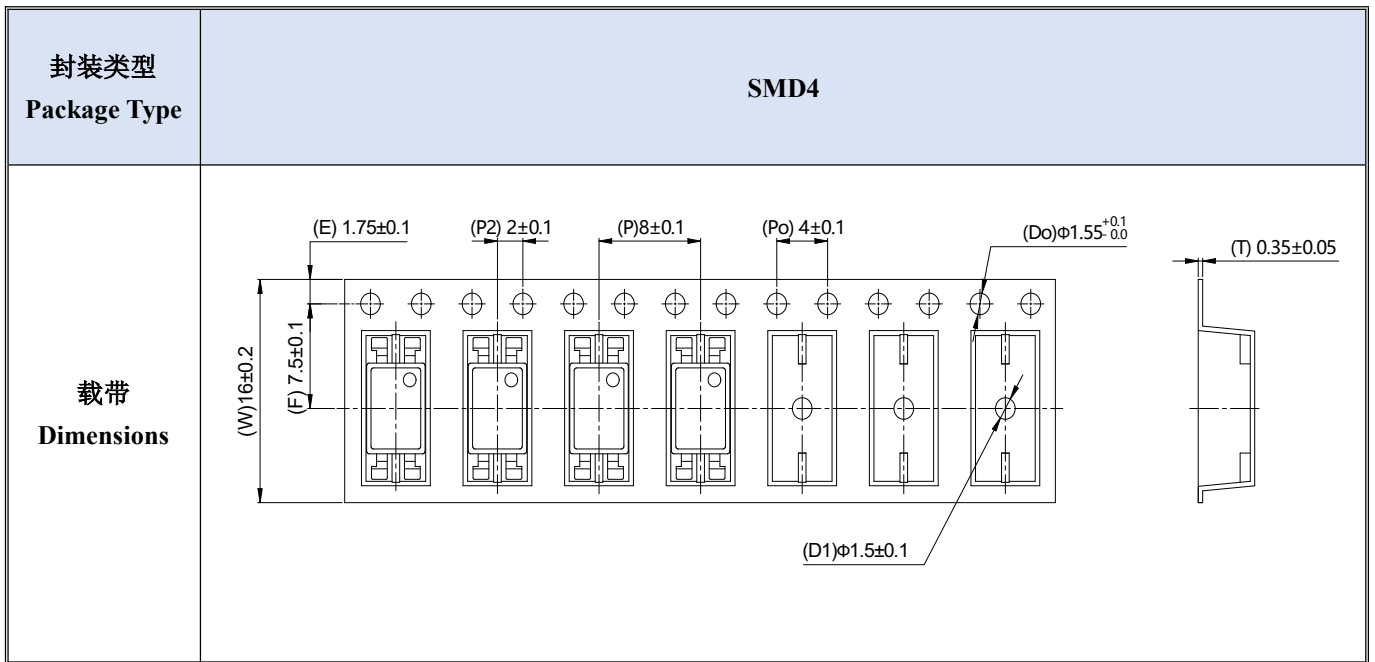

单位: mm



## 回流焊温度曲线 Solder Reflow Temperature Profile

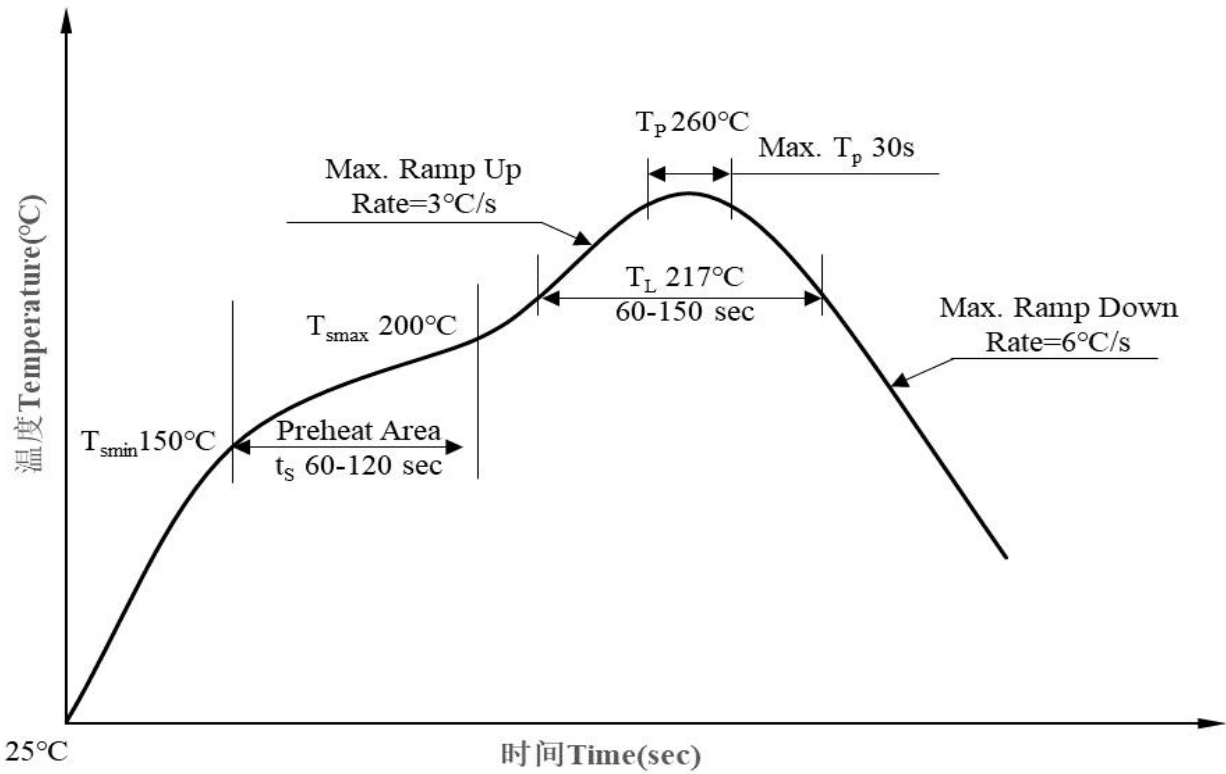

曲线项目 Profile Item		符号 Symbol	数值 Value	单位 Unit
预热区 Preheat Area	最低温度 Temperature Min.	T <sub>smin</sub>	150	°C
	最高温度 Temperature Max.	T <sub>smax</sub>	200	°C
	时间 Time (min. to max.)	t <sub>s</sub>	60~120	sec
焊接区 Soldering Area	温度 Temperature	T <sub>L</sub>	217	°C
	时间 Time	t <sub>L</sub>	60~150	sec
峰值温度 Peak Temperature		T <sub>p</sub>	260	°C
峰值温度 T <sub>p</sub> 至 T <sub>p</sub> -5°C 之间的时间 Time within 5 °C of Peak Temperature: T <sub>p</sub> - 5°C		t <sub>p</sub>	30	sec max.
上升速率 Ramp-up rate		/	3	°C / sec max.
下降速率 Ramp-down rate		/	6	°C / sec max.

注：参考 IPC/JEDEC J-STD-020D 标准。

Note: Reference: IPC/JEDEC J-STD-020D.

建议在所示的温度和时间条件下进行回流焊，最多不能超过三次。

One time soldering reflow is recommended within the condition of temperature and time profile shown below. Do not solder more than three times.



## 波峰焊温度曲线 Wave soldering Temperature Profile

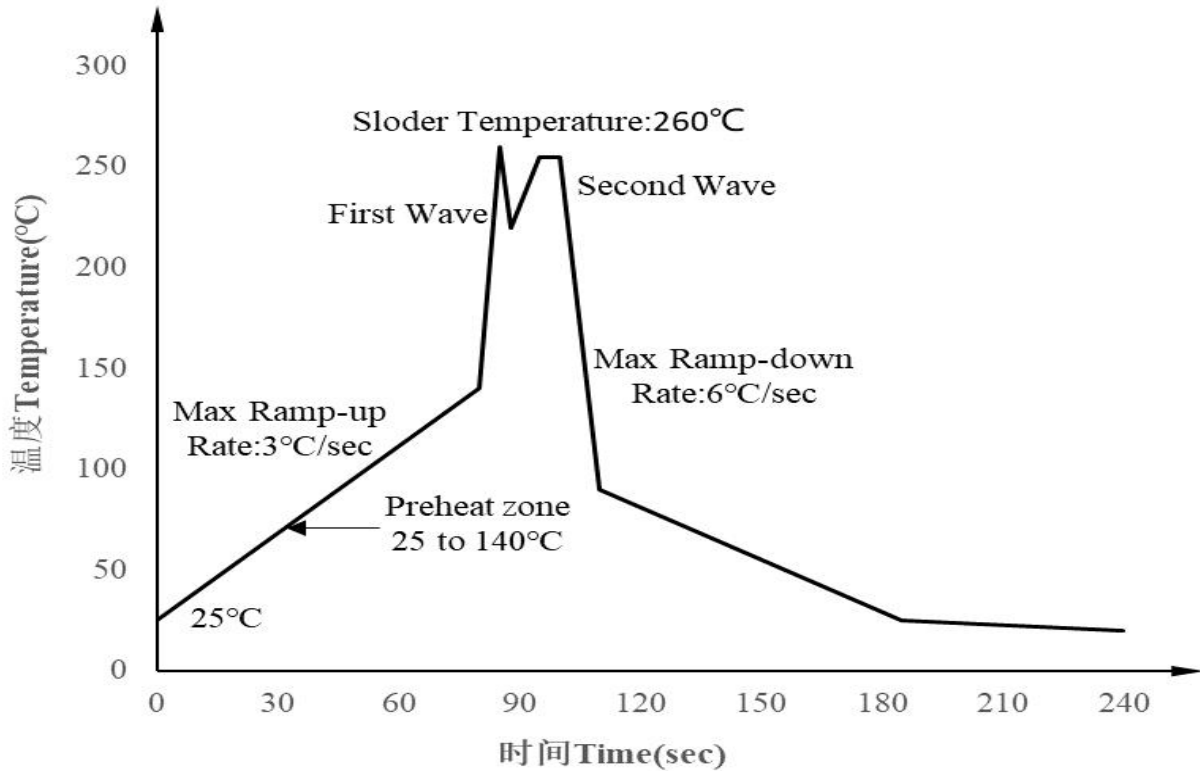

详情请参考 JEDEC 标准 JESD22-A111

For more details, please refer to the JESD22-A111 of JEDEC standards.

## 手工烙铁焊接 Hand soldering by soldering iron

- (1) 建议一次完成焊接。  
One time soldering is recommended.
- (2) 温度  $360^{\circ}\text{C} \pm 5^{\circ}\text{C}$ , 时间  $\leq 3\text{s}$ 。  
Temperature:  $360^{\circ}\text{C} \pm 5^{\circ}\text{C}$ , within 3s.

## 声明 Disclaimer

1. 为提高产品可靠性、功能或设计或其他方面，硅耐所有产品规格可能会进行更改，恕不另行通知。  
Silicon Nice all product specifications are subject to change without notice to improve reliability, function or design or otherwise.
2. 使用本产品时请遵守规格书中的说明，硅耐对使用不符合这些规格表中说明的产品造成的损坏不承担任何责任。  
When using this product, please observe the instructions in this specifications. Silicon Nice assumes no responsibility for any damage resulting from use of the product which does not comply with the instructions included in this specification sheets.
3. 本规格书所展示的产品为电子应用中的一般用途而设计，如办公自动化设备、通信设备、音频/视频设备、电气应用和仪器仪表等。  
The products shown in this specifications are designed for the general use in electronic applications such as office automation equipment, communications devices, audio/visual equipment, electrical application and instrumentation,etc.
4. 对于需要高可靠性或安全性的设备/装置，如太空应用、核电控制设备、医疗设备、任何“特定”应用等，请联系我们的销售代表。  
For equipment/devices where high reliability or safety is required, such as space applications, nuclear power control equipment, medical equipment, any "specific" application,etc, please contact our sales representatives.
5. 如对文件中表述的内容有疑问，欢迎联系我们。  
If you have any questions about the contents of the document, please contact us.